

REVISIONS

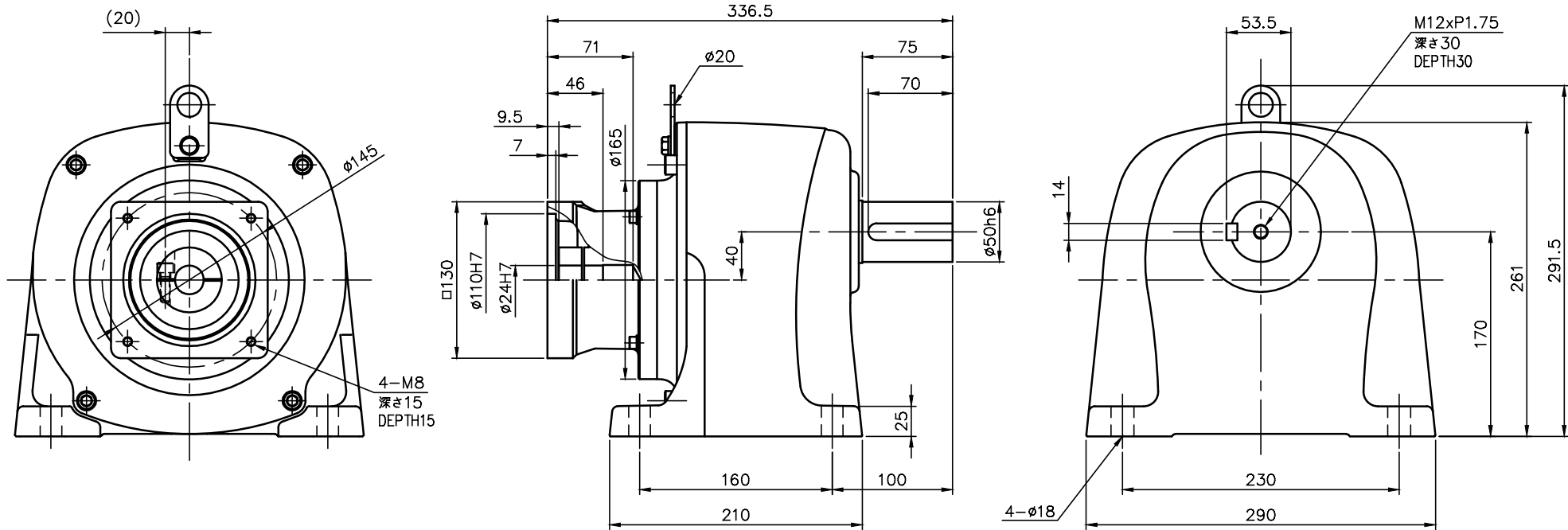

減速機仕様 REDUCER SPECIFICATION

名称 TYPE	GTR
枠番 FRAME NO.	50
減速比 RATIO	1/100 1/120 1/160 1/200
潤滑 LUBRICATION	グリース GREASE
塗色 PAINT COLOR	グレー (マンセル値 9B6/0.5) GRAY (MUNSELL 9B6/0.5)

● 連続定格入力トルクで6.4N・m以下で使用して下さい。  
Please use at a continuous rated input torque of 6.4 N·m or less.

TITLE		AGALZ50-100~200L2000K33		
		外形寸法図 DIMENSION OF MODEL		
DRAWING NO.		AGALZ50-L2000K33		
USER				
NOTICE				
APPROVE	Y.Fukatsu	SCALE	UNIT	DATE
CHECK	K.Naruse			
DESIGN	K.Hori			
		1:5	mm	2026.02.25
NISSEI CORPORATION				