

DRAWING NO.

REVISIONS

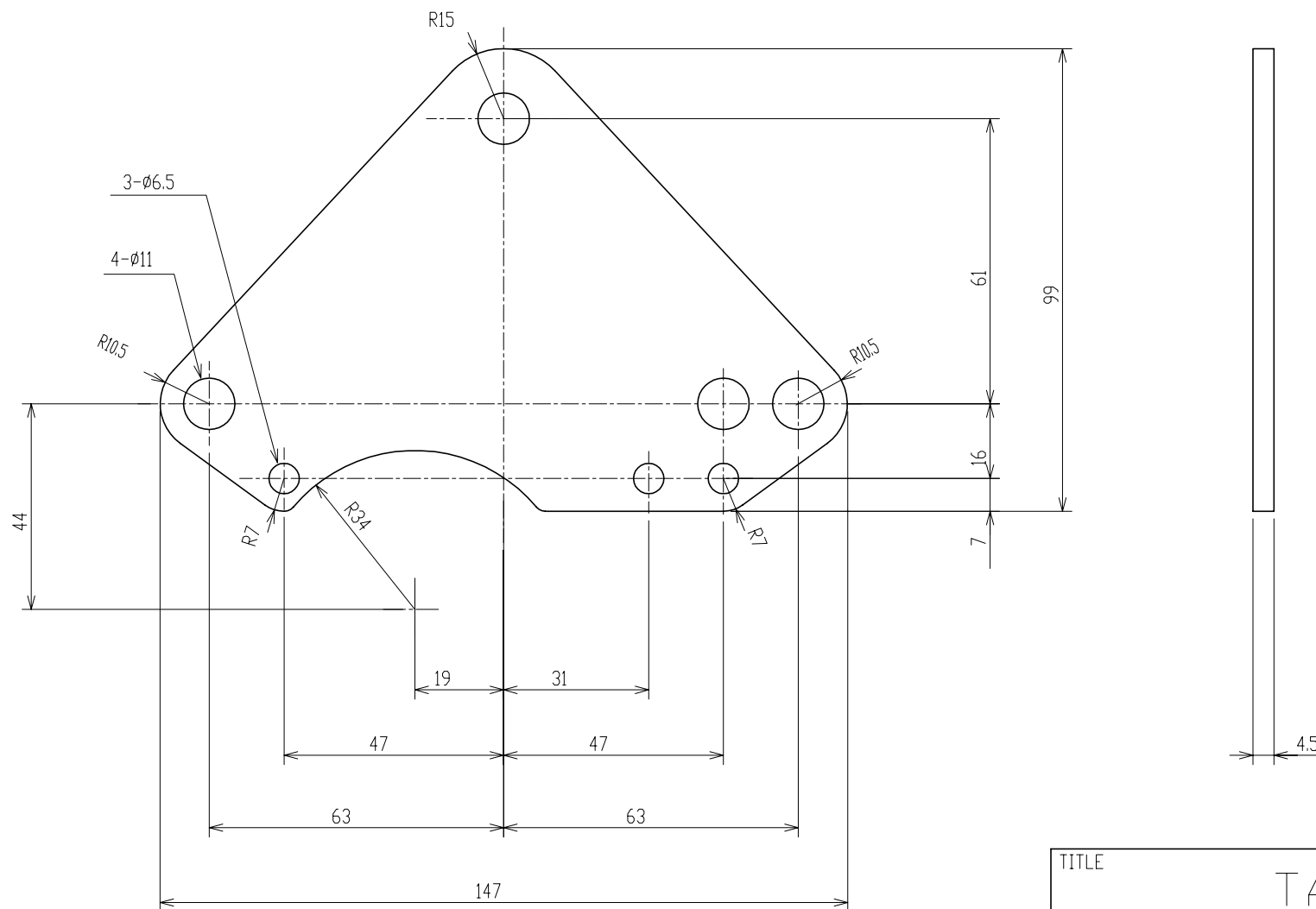

TITLE						TA-25		
DRAWING NO.								
USER								
NOTICE								
APPROVE	CHECK	DESIGN	SCALE		UNIT	DATE		
海野	永坂	鈴木	Free		mm	2004. 7.15		
						NISSEI CORPORATION		