

DRAWING NO.

REVISIONS

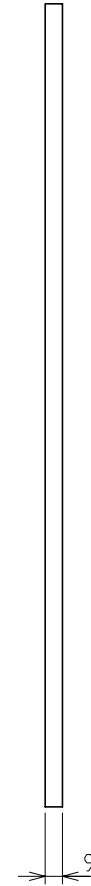
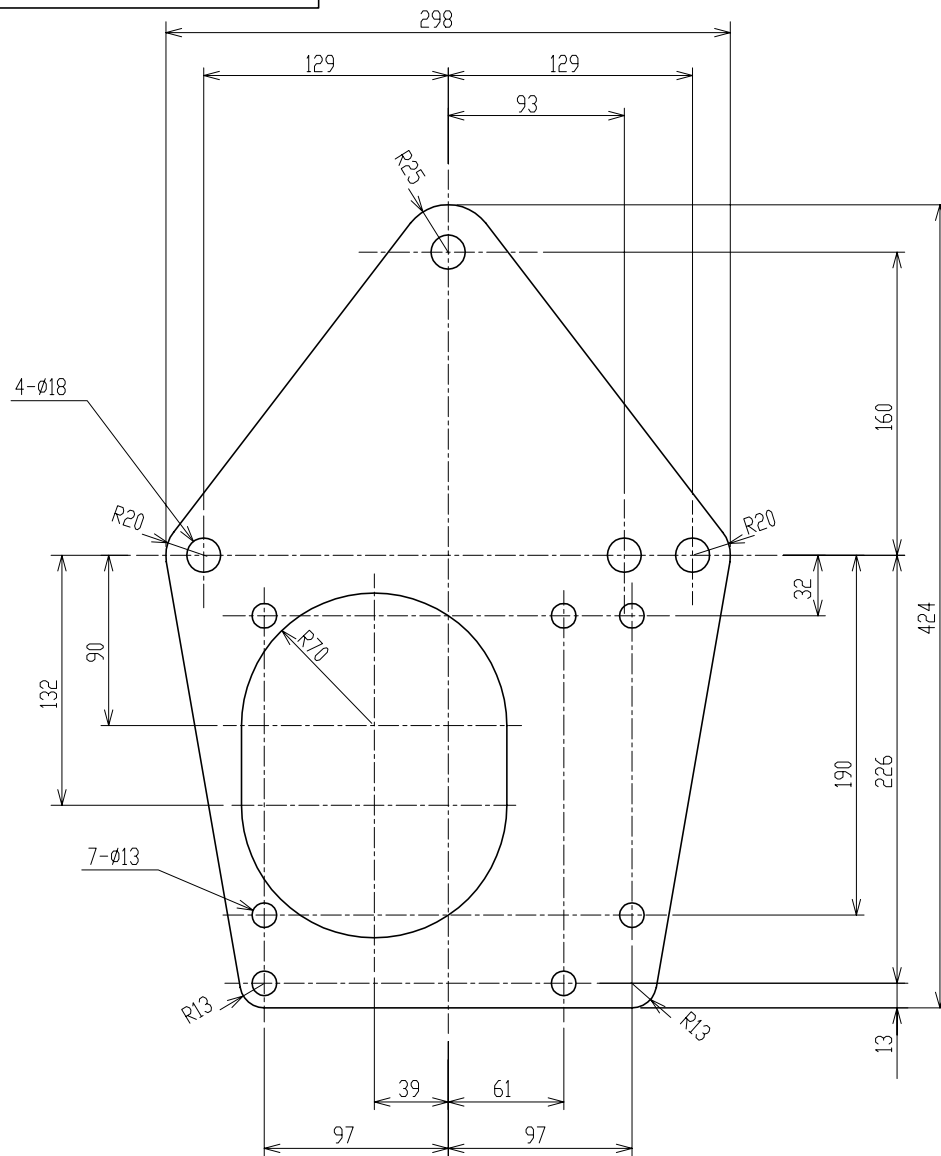
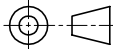

TITLE		TA-55				
DRAWING NO.						
USER						
NOTICE						
APPROVE	CHECK	DESIGN	SCALE		UNIT	DATE
海野	永坂	鈴木	free		mm	2004. 7.15
NISSEI CORPORATION						