

REVISIONS

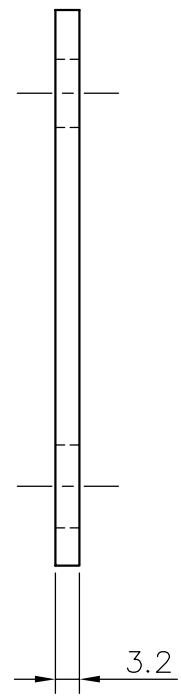
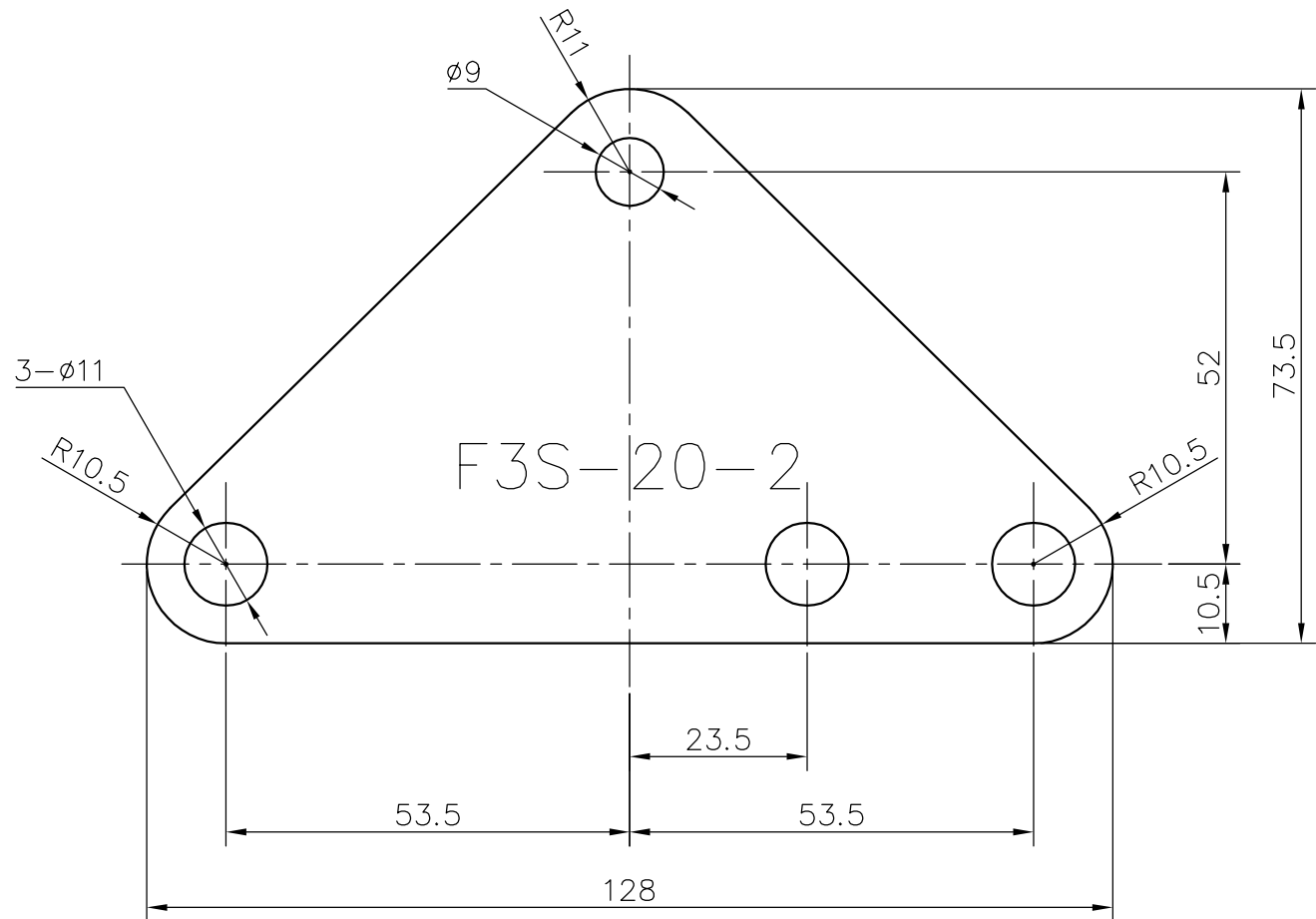

TITLE		TAF3S-20-2 外形寸法図		
DRAWING NO.		TAF3S-20-2		
USER				
NOTICE				
APPROVE	CHECK	DESIGN	SCALE	UNIT
萩原	田島	原口	1:1	mm
				DATE
				2006.09.22
NISSEI CORPORATION				