

REVISIONS

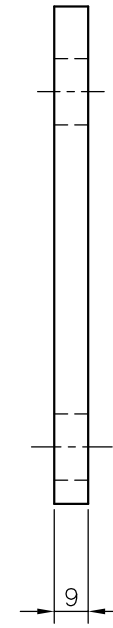
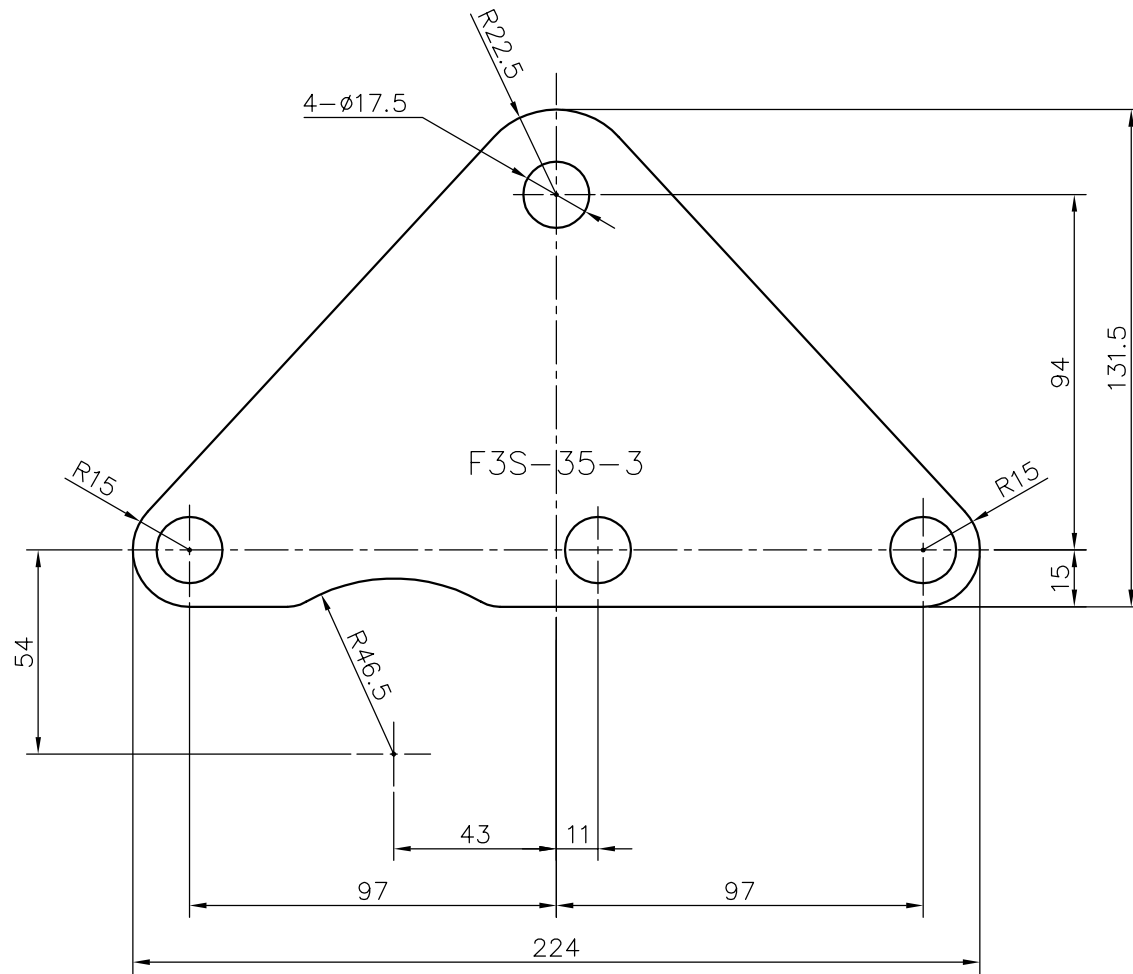

TITLE		TAF3S-35-3 外形寸法図		
DRAWING NO.		TAF3S-35-3		
USER				
NOTICE				
APPROVE	CHECK	DESIGN	SCALE	UNIT
萩原	田島	原口	1:2	mm
			DATE	2006.09.22
			NISSEI CORPORATION	